

NEW SUMMER



FROID
MATÉRIEL
PROFESSIONNEL

NEW SUMMER



VITRINE SERVICE ARRIERE VENTE TRADITIONNELLE

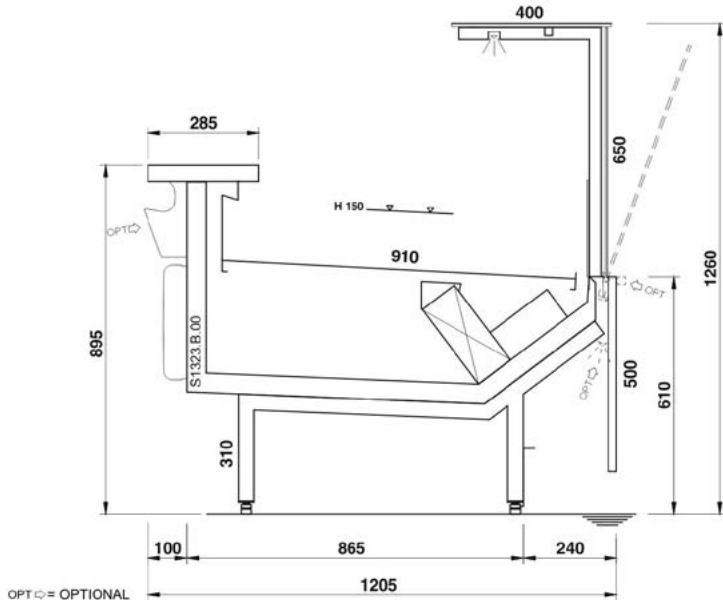

Version standard réfrigérée

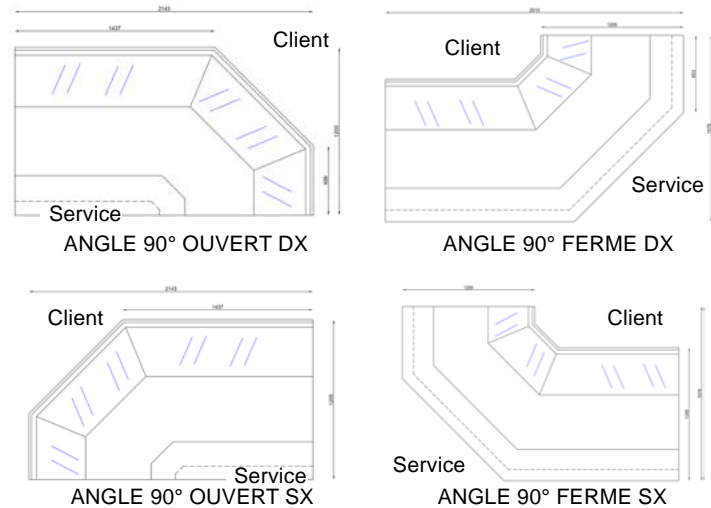

DESCRIPTIF

- Meuble canalisable
- 2 joues standards double-vitrage
- Glace droite rabattable avec système de maintien à l'ouverture et structure montée d'usine en INOX
- Cuve INOX AISI 304
- Plateau d'exposition INOX AISI 304 P. 910 mm
- Tablette arrière de travail INOX GAUFFRE P. 285 mm
- Tablette supérieure en verre avec simple éclairage LED ROSE (BLANC en option)
- Avec réserve réfrigérée à portillons
- Plinthes INOX
- Bandeau de façade nuancier au choix, voir couleurs

CARACTERISTIQUES TECHNIQUES

- Réfrigération ventilée, vitesse de ventilation réglée d'usine en fonction du type de produit
- Ventilation frontale anti-buée
- Evaporateur anti corrosion traité cataphorèse
- Température de fonctionnement - 1°C/ + 5°C – Classe 3M1

- VERSION GROUPE LOGE R 290
- Régulation électronique ELIWELL (autre régulation nous consulter)
- Dégivrage naturel
- Ré évaporation automatique des eaux de dégivrage

- VERSION GROUPE EXTERIEUR
- Détendeur thermostatique monté soudé au R 449 A (autre détendeur, nous consulter)
- Centrale non fournie
- Régulation électronique ELIWELL (autre régulation nous consulter)
- Dégivrage naturel
- Evacuation des eaux de dégivrage à l'égout

- DISPONIBLE EN VERSION BOULANGERIE - BAIN MARIE - LIBRE SERVICE

MODULES

| Longueurs en mm | | Nombre portillons réserve | Angles |
|-----------------|------------|---------------------------|---------------|
| Sans joue | Avec joues | | |
| 938 | 1018 | 1 | 90° DX OUVERT |
| 1250 | 1330 | 1 | 90° DX FERME |
| 1563 | 1643 | 1 | 90° SX OUVERT |
| 1875 | 1955 | 2 | 90° SX FERME |
| 2500 | 2580 | 3 | |
| 3125 | 3205 | 4 | |
| 3750 | 3830 | 5 | |

COLORIS RAL OU BOIS AU CHOIX



Couleurs RAL et BOIS, voir page suivante

OPTIONS

- Meuble caisse L. 625 - 938 mm
- Meuble caisse PMR
- Planche de coupe
- Porte balance
- Porte couteaux
- Roulettes
- Séparation plexi
- Fermeture arrière plexi
- Plateau d'exposition RAL NOIR 9005
- Rideau de nuit
- Pare chocs Inox
- Eclairage LED BLANC de soubassement
- Etagère intermédiaire avec ou sans éclairage LED ROSE

NEW SUMMER



VITRINE SERVICE ARRIERE VENTE TRADITIONNELLE

VERSION LIBRE SERVICE

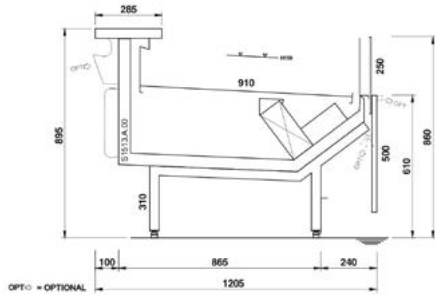

MODULES

Longueurs en mm

Sans joue Avec joues

| | |
|------|------|
| 938 | 1018 |
| 1250 | 1330 |
| 1563 | 1643 |
| 1875 | 1955 |
| 2500 | 2580 |
| 3125 | 3205 |
| 3750 | 3830 |

Nombre portillons réserve

- 1
- 1
- 2
- 3
- 4
- 5

VERSION NEUTRE - BOULANGERIE MODULES

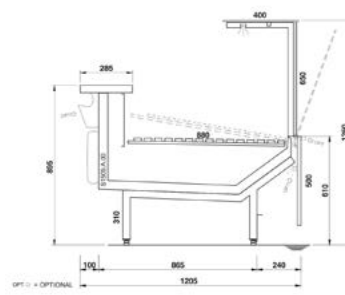

Longueurs en mm

Sans joue Avec joues

| | |
|------|------|
| 1250 | 1330 |
|------|------|

VERSION CHAUDE - BAIN MARIE

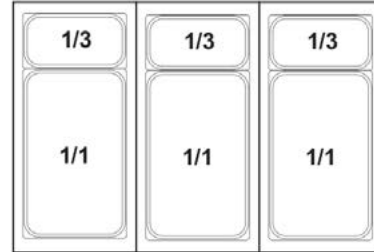
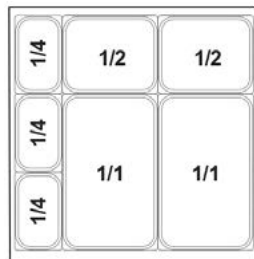
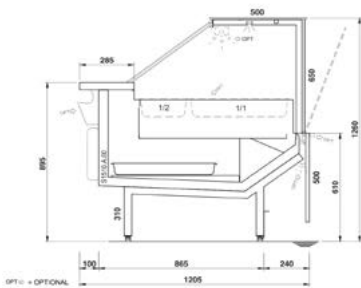

MODULES

Longueurs en mm

Sans joue Avec joues

| | |
|------|------|
| 938 | 1018 |
| 1250 | 1330 |



NEW SUMMER

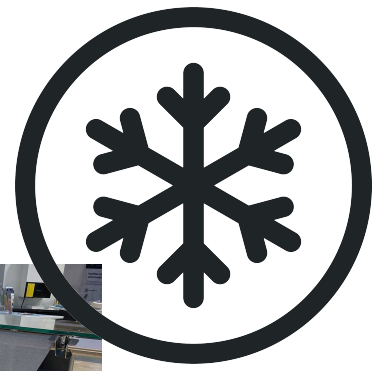

ACCESSOIRES & OPTIONS



Réserves réfrigérées



Rideau de nuit

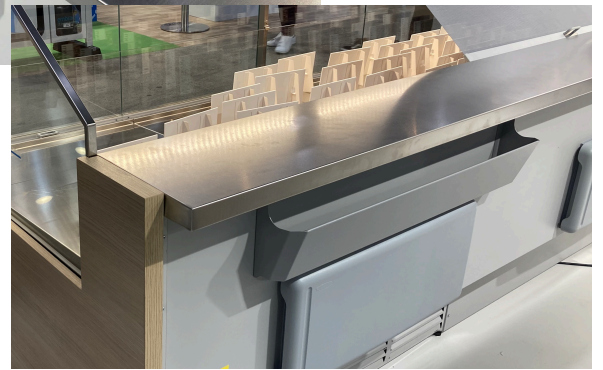

Case à papier



Ouverture à la française



Planche de coupe

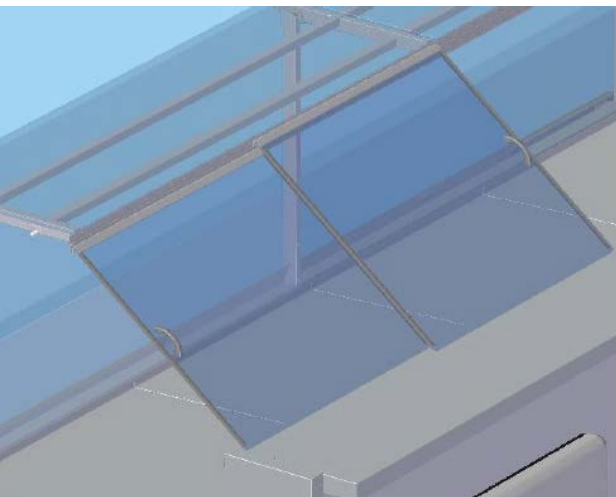

Plexi arrière coulissants

NEW SUMMER



MEUBLE CAISSE

L. 700 ou 1000 mm* Adaptable à vos espaces

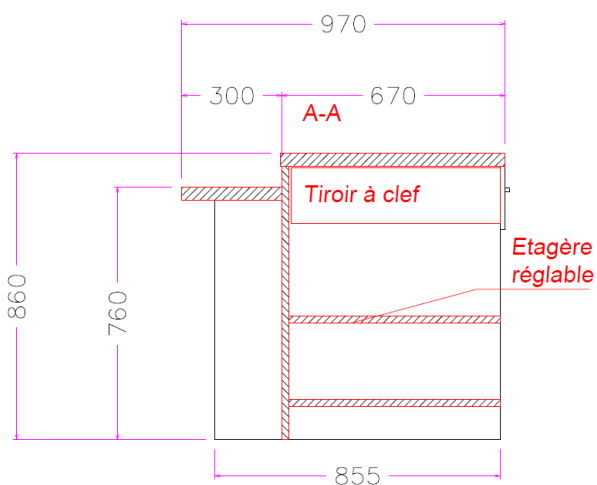
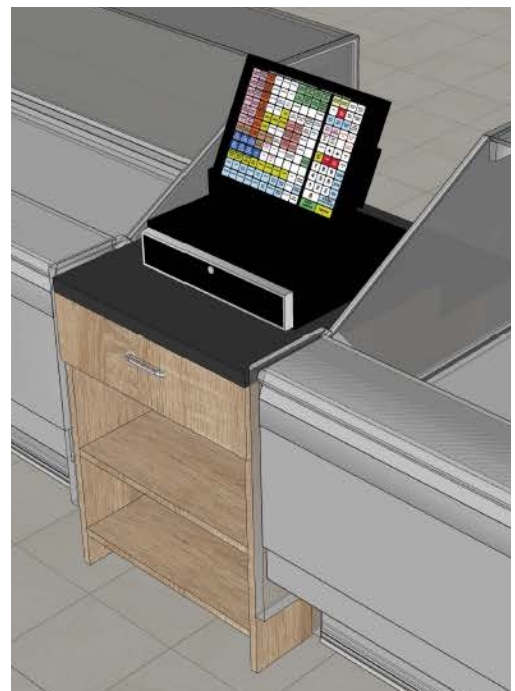
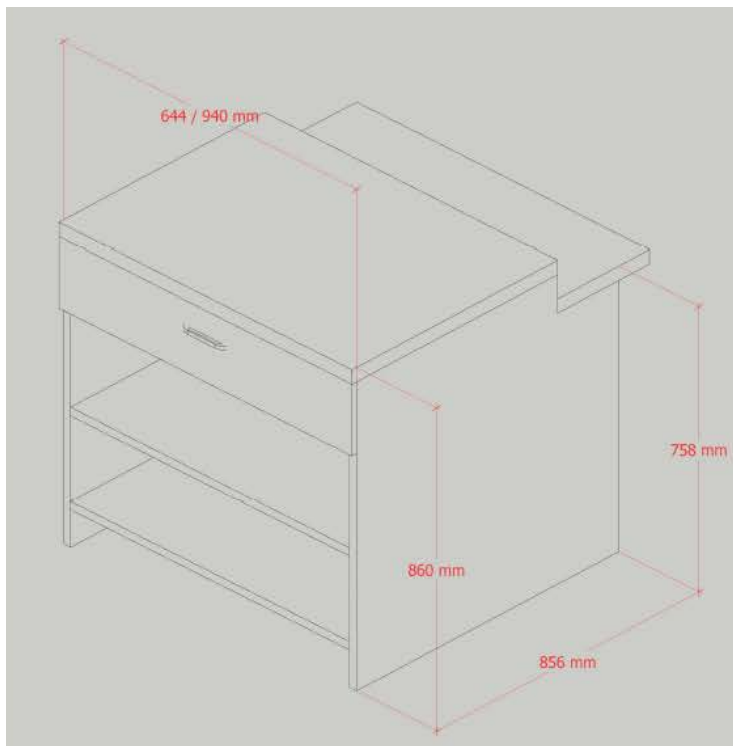
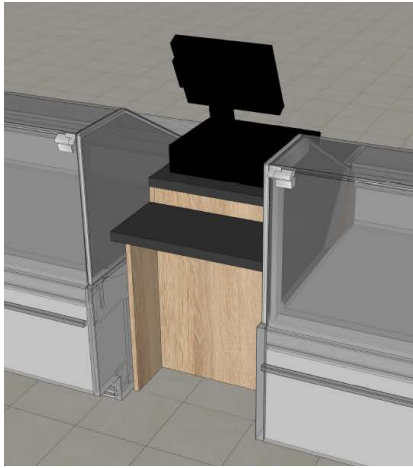

NEW SUMMER



FINITION BOIS - GAMME EGGER

Bois grainage vertical



*Polar Aland pine**



*Light Lakeland acacia**



*Natural Bardolino oak**



*Natural Nebraska oak**



*Grey Arizona oak**



*Brown Arizona oak**



*Natural Hamilton oak**



*Grey Corbridge oak**



*Graphite Denver oak**



*Black-Brown Thermo oak**

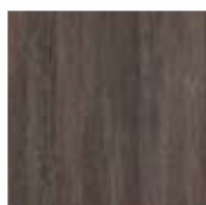

*Mali wenge**



*Vicenza oak**



*Natural Halifax oak**



*Sealand pine**

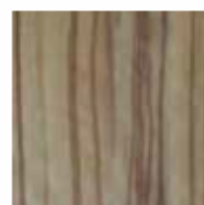

*Olivier de Séville**

Bois grainage horizontal

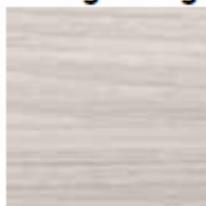

*Polar Aland pine**



*Light Lakeland acacia**



*Natural Bardolino oak**



*Natural Nebraska oak**



*Grey Arizona oak**



*Brown Arizona oak**



*Natural Hamilton oak**



*Grey Corbridge oak**

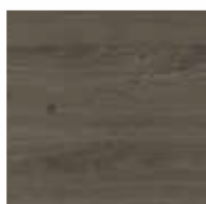

*Graphite Denver oak**

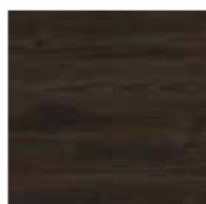

*Black-Brown Thermo oak**



*Mali wenge**



*Vicenza oak**



*Natural Halifax oak**



*Sealand pine**



*Olivier de Séville**

NEW SUMMER



COLORIS RAL

| | | | | | | | | | | | |
|----------|----------|----------|----------|----------|----------|----------|----------|----------|----------|----------|----------|
| RAL 1000 | RAL 1023 | RAL 2009 | RAL 3017 | RAL 4010 | RAL 5018 | RAL 6010 | RAL 6027 | RAL 7009 | RAL 7034 | RAL 8002 | RAL 8028 |
| RAL 1001 | RAL 1024 | RAL 2010 | RAL 3018 | RAL 4011 | RAL 5019 | RAL 6011 | RAL 6028 | RAL 7010 | RAL 7035 | RAL 8003 | RAL 8029 |
| RAL 1002 | RAL 1026 | RAL 2011 | RAL 3020 | RAL 4012 | RAL 5020 | RAL 6012 | RAL 6029 | RAL 7011 | RAL 7036 | RAL 8004 | RAL 9001 |
| RAL 1003 | RAL 1027 | RAL 2012 | RAL 3022 | RAL 5000 | RAL 5021 | RAL 6013 | RAL 6032 | RAL 7012 | RAL 7037 | RAL 8007 | RAL 9002 |
| RAL 1004 | RAL 1028 | RAL 2013 | RAL 3024 | RAL 5001 | RAL 5022 | RAL 6014 | RAL 6033 | RAL 7013 | RAL 7038 | RAL 8008 | RAL 9003 |
| RAL 1005 | RAL 1032 | RAL 3000 | RAL 3026 | RAL 5002 | RAL 5023 | RAL 6015 | RAL 6034 | RAL 7015 | RAL 7039 | RAL 8011 | RAL 9004 |
| RAL 1006 | RAL 1033 | RAL 3001 | RAL 3027 | RAL 5003 | RAL 5024 | RAL 6016 | RAL 6035 | RAL 7016 | RAL 7040 | RAL 8012 | RAL 9005 |
| RAL 1007 | RAL 1034 | RAL 3002 | RAL 3031 | RAL 5004 | RAL 5025 | RAL 6017 | RAL 6036 | RAL 7021 | RAL 7042 | RAL 8014 | RAL 9006 |
| RAL 1011 | RAL 1035 | RAL 3003 | RAL 3032 | RAL 5005 | RAL 5026 | RAL 6018 | RAL 7000 | RAL 7022 | RAL 7043 | RAL 8015 | RAL 9007 |
| RAL 1012 | RAL 1036 | RAL 3004 | RAL 3033 | RAL 5007 | RAL 6000 | RAL 6019 | RAL 7001 | RAL 7023 | RAL 7044 | RAL 8016 | RAL 9010 |
| RAL 1013 | RAL 1037 | RAL 3005 | RAL 4001 | RAL 5008 | RAL 6001 | RAL 6020 | RAL 7002 | RAL 7024 | RAL 7045 | RAL 8017 | RAL 9011 |
| RAL 1014 | RAL 2000 | RAL 3007 | RAL 4002 | RAL 5009 | RAL 6002 | RAL 6021 | RAL 7003 | RAL 7026 | RAL 7046 | RAL 8019 | RAL 9016 |
| RAL 1015 | RAL 2001 | RAL 3009 | RAL 4003 | RAL 5010 | RAL 6003 | RAL 6022 | RAL 7004 | RAL 7030 | RAL 7047 | RAL 8022 | RAL 9017 |
| RAL 1016 | RAL 2002 | RAL 3011 | RAL 4004 | RAL 5011 | RAL 6004 | RAL 6024 | RAL 7005 | RAL 7031 | RAL 7048 | RAL 8023 | RAL 9018 |
| RAL 1017 | RAL 2003 | RAL 3012 | RAL 4005 | RAL 5012 | RAL 6005 | RAL 6025 | RAL 7006 | RAL 7032 | RAL 8000 | RAL 8024 | RAL 9022 |
| RAL 1018 | RAL 2004 | RAL 3013 | RAL 4006 | RAL 5013 | RAL 6006 | RAL 6026 | RAL 7008 | RAL 7033 | RAL 8001 | RAL 8025 | RAL 9023 |
| RAL 1019 | RAL 2005 | RAL 3014 | RAL 4007 | RAL 5014 | RAL 6007 | | | | | | |
| RAL 1020 | RAL 2007 | RAL 3015 | RAL 4008 | RAL 5015 | RAL 6008 | | | | | | |
| RAL 1021 | RAL 2008 | RAL 3016 | RAL 4009 | RAL 5017 | RAL 6009 | | | | | | |



FROID
MATÉRIEL
PROFESSIONNEL

Le choix de la couleur RAL s'entend sous réserve des disponibilités usine au moment de la commande ; en cas d'indisponibilité, nous vous proposons une couleur RAL rapprochant.

Les décors et couleurs représentés sur ce support sont informatisés ; il peut donc exister de légères modifications par rapport aux couleurs de panneaux, tant au niveau du brillant, de la teinte que de la structure superficielle.

FMP

FROID ❄️
MATÉRIEL
PROFESSIONNEL



03 26 35 79 53



CONTACT@FMPFROID.FR



**29 RUE JOSEPH CUGNOT
51430 REIMS -TINQUEUX**



Suivez nous sur LinkedIn

www.fmpfroid.fr

**TÉLÉCHARGEZ NOTRE
CATALOGUE ANNUEL**

